

R&S® ZCxxx

MILLIMETERWAVE CONVERTERS

Specifications

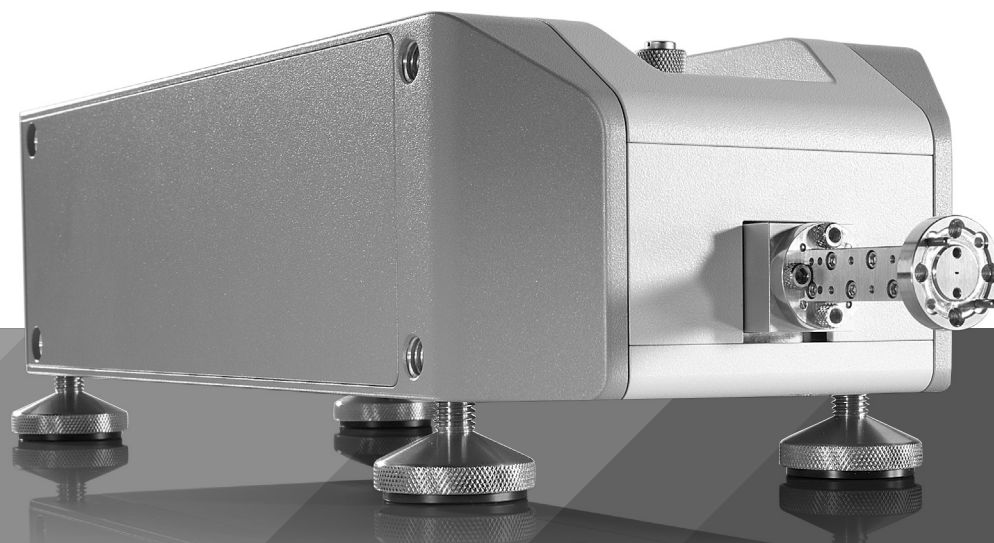

Data Sheet
Version 15.00

4TECT

ООО «4TECT»
Телефон: +7 (499) 685-4444
info@4test.ru
www.4test.ru

ROHDE & SCHWARZ

Make ideas real



Definitions

General

Product data applies under the following conditions:

- Three hours storage at ambient temperature followed by 30 minutes warm-up operation
- Specified environmental conditions met
- Recommended calibration interval adhered to
- All internal automatic adjustments performed, if applicable

Specifications with limits

Represent warranted product performance by means of a range of values for the specified parameter. These specifications are marked with limiting symbols such as $<$, \leq , $>$, \geq , \pm , or descriptions such as maximum, limit of, minimum. Compliance is ensured by testing or is derived from the design. Test limits are narrowed by guard bands to take into account measurement uncertainties, drift and aging, if applicable.

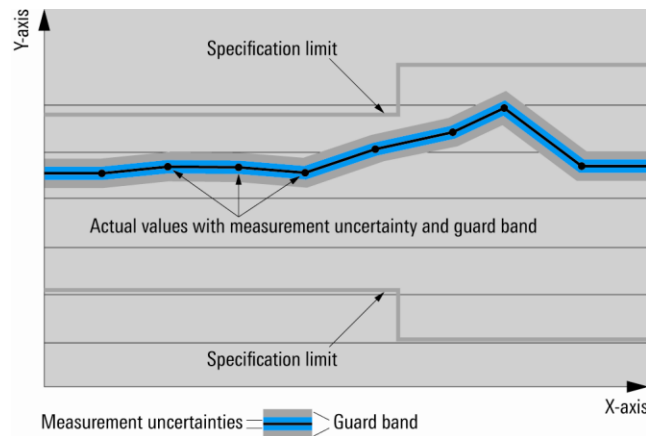

Non-traceable specifications with limits (n. trc.)

Represent product performance that is specified and tested as described under “Specifications with limits” above. However, product performance in this case cannot be warranted due to the lack of measuring equipment traceable to national metrology standards. In this case, measurements are referenced to standards used in the Rohde & Schwarz laboratories.

Specifications without limits

Represent warranted product performance for the specified parameter. These specifications are not specially marked and represent values with no or negligible deviations from the given value (e.g. dimensions or resolution of a setting parameter). Compliance is ensured by design.

Typical data (typ.)

Characterizes product performance by means of representative information for the given parameter. When marked with $<$, $>$ or as a range, it represents the performance met by approximately 80 % of the instruments at production time. Otherwise, it represents the mean value.

Nominal values (nom.)

Characterize product performance by means of a representative value for the given parameter (e.g. nominal impedance). In contrast to typical data, a statistical evaluation does not take place and the parameter is not tested during production.

Measured values (meas.)

Characterize expected product performance by means of measurement results gained from individual samples.

Uncertainties

Represent limits of measurement uncertainty for a given measurand. Uncertainty is defined with a coverage factor of 2 and has been calculated in line with the rules of the Guide to the Expression of Uncertainty in Measurement (GUM), taking into account environmental conditions, aging, wear and tear.

Device settings and GUI parameters are indicated as follows: “parameter: value”.

Non-traceable specifications with limits, typical data as well as nominal and measured values are not warranted by Rohde & Schwarz.

General information

The R&S®ZCxxx/RPG ZCxxx millimeterwave converters are optional for the following vector network analyzers:

- R&S®ZNA26, R&S®ZNA43
- R&S®ZVA24, R&S®ZVA40, R&S®ZVA50, R&S®ZVA67

The converters facilitate measurements in the millimeterwave frequency range from 50 GHz to 750 GHz.

The R&S®ZCxxx millimeterwave converters are available for the frequency bands from:

- 50 GHz to 75 GHz (R&S®ZC75)
- 60 GHz to 90 GHz (R&S®ZC90) ¹
- 60 GHz to 90 GHz (R&S®ZC90E) ^{1,2}
- 75 GHz to 110 GHz (R&S®ZC110)
- 90 GHz to 140 GHz (R&S®ZC140)
- 110 GHz to 170 GHz (R&S®ZC170)
- 140 GHz to 220 GHz (R&S®ZC220)
- 170 GHz to 260 GHz (RPG ZC260) ¹
- 220 GHz to 330 GHz (R&S®ZC330)
- 260 GHz to 400 GHz (RPG ZC400) ¹
- 330 GHz to 500 GHz (R&S®ZC500)
- 500 GHz to 750 GHz (RPG ZC750) ¹
- 750 GHz to 1100 GHz (RPG ZC1100) ¹

The millimeterwave converters consist of a dedicated reflectometer module containing a directional coupler, a frequency multiplier for generating the source signal and two harmonic mixers as downconverters. Some converter models are also fitted with a manually adjustable attenuator in order to change the output power. In addition, the millimeterwave converters allow output power leveling and power sweeps by adjusting the RF input power.

The R&S®ZNAxx network analyzers must be configured with the R&S®ZNA-K8 option and either the R&S®ZNAxx-B16 or R&S®ZNA-B26 option. Together with the R&S®ZNA-B8 option, each port of the R&S®ZNAxx network analyzers can be equipped with a millimeterwave converter using the dedicated mmWave converter LO from the rear panel of the R&S®ZNAxx.

The R&S®ZVAxx network analyzer must be equipped with the R&S®ZVAxx-B16 and R&S®ZVA-K8 options.

The R&S®ZCxxx/RPG ZCxxx millimeterwave converters come with the following accessories:

- Hex ball driver
- Two coaxial cables with SMA connectors for the reference and measurement output signals
- Waveguide-to-waveguide adapter (test port adapter, factory mounted)
- DC cable and USB cable
- Waveguide flange screws and dowel pins
- Documentation

The R&S®ZCxxx/RPG ZCxxx millimeterwave converters must be operated with the R&S®ZCPS power supply module (see ordering information; one module supplies two converters).

¹ The following vector network analyzer models are recommended: R&S®ZNAxx, R&S®ZVA24 (model .28), R&S®ZVA40 (model .48), R&S®ZVA67 (model .02 and model .04).

² R&S®ZNAxx vector network analyzers do not support the electronic attenuator.

Specifications

Test port

Frequency range	R&S®ZC75	50 GHz to 75 GHz
	R&S®ZC90 and R&S®ZC90E	60 GHz to 90 GHz
	R&S®ZC110	75 GHz to 110 GHz
	R&S®ZC140	90 GHz to 140 GHz
	R&S®ZC170	110 GHz to 170 GHz
	R&S®ZC220	140 GHz to 220 GHz
	RPG ZC260	170 GHz to 260 GHz
	R&S®ZC330	220 GHz to 330 GHz
	RPG ZC400	260 GHz to 400 GHz
	R&S®ZC500	330 GHz to 500 GHz
	RPG ZC750	500 GHz to 750 GHz
	RPG ZC1100	750 GHz to 1100 GHz
Waveguide designator	R&S®ZC75	WR15
	R&S®ZC90 and R&S®ZC90E	WR12
	R&S®ZC110	WM-2540 (WR10)
	R&S®ZC140	WM-2032 (WR8.0)
	R&S®ZC170	WM-1651 (WR6.5)
	R&S®ZC220	WM-1295 (WR5.1)
	RPG ZC260	WM-1092 (WR4.3)
	R&S®ZC330	WM-864 (WR3.4)
	RPG ZC400	WM-710
	R&S®ZC500	WM-570
	RPG ZC750	WM-380
	RPG ZC1100	WM-250
Connector type	anti-cocking flange	Rohde & Schwarz precision waveguide flange, compatible with flange types UG-387/U-M and IEEE 1785.2
Output power	at +7 dBm input power from the R&S®ZNA/R&S®ZVA	
	R&S®ZC75	
	50 GHz to 75 GHz	> +10 dBm (n. trc.), typ. +12 dBm
	R&S®ZC90	
	60 GHz to 90 GHz	> +7 dBm (n. trc.), typ. +10 dBm
	R&S®ZC90E	
	60 GHz to 90 GHz	> +2 dBm (n. trc.), typ. +6 dBm
	R&S®ZC110	
	75 GHz to 110 GHz	> +12 dBm (n. trc.), typ. +15 dBm
	R&S®ZC140	
	90 GHz to 95 GHz	> +5 dBm (n. trc.), typ. +7 dBm
	95 GHz to 135 GHz	> +7 dBm (n. trc.), typ. +9 dBm
	135 GHz to 140 GHz	> +5 dBm (n. trc.), typ. +7 dBm
	R&S®ZC170	
	110 GHz to 170 GHz	> +6 dBm (n. trc.), typ. +9 dBm
	R&S®ZC220	
	140 GHz to 220 GHz	> -2 dBm (n. trc.), typ. +1 dBm
	RPG ZC260	
	170 GHz to 260 GHz	> -6 dBm (n. trc.), typ. -2 dBm
	R&S®ZC330	
	220 GHz to 330 GHz	> -10 dBm (n. trc.), typ. -7 dBm
	RPG ZC400	
	260 GHz to 400 GHz	> -15 dBm (n. trc.), typ. -12 dBm
	R&S®ZC500	
	330 GHz to 500 GHz	> -15 dBm (n. trc.), typ. -11 dBm
	RPG ZC750	
500 GHz to 750 GHz	> -25 dBm (n. trc.), typ. -18 dBm	
RPG ZC1100		
750 GHz to 1100 GHz	> -30 dBm (n. trc.), typ. -25 dBm	

Output power attenuation	R&S®ZC75, manually adjustable	0 dB to 40 dB
	R&S®ZC90, no manual adjustment	
	R&S®ZC90E, electronically adjustable	0 dB to 25 dB
	R&S®ZC110, no manual adjustment	
	R&S®ZC140, manually adjustable	0 dB to 40 dB
	R&S®ZC170, manually adjustable	0 dB to 40 dB
	R&S®ZC220, manually adjustable	0 dB to 40 dB
	RPG ZC260, manually adjustable	0 dB to 40 dB
	R&S®ZC330, manually adjustable	0 dB to 40 dB
	RPG ZC400, manually adjustable	0 dB to 40 dB
	R&S®ZC500, manually adjustable	0 dB to 40 dB
	RPG ZC750, manually adjustable	0 dB to 40 dB
	RPG ZC1100, no manual adjustment	
	Output power flatness across the waveguide band at minimum attenuation (peak-to-peak)	at 0 dB attenuator setting
R&S®ZC75		< 7 dB (n. trc.)
R&S®ZC90 and R&S®ZC90E		< 7 dB (n. trc.)
R&S®ZC110		< 6 dB (n. trc.)
R&S®ZC140		< 6 dB (n. trc.)
R&S®ZC170		< 7 dB (n. trc.)
R&S®ZC220		< 7 dB (n. trc.)
RPG ZC260		< 7 dB (n. trc.)
R&S®ZC330		< 7 dB (n. trc.)
RPG ZC400		< 13 dB (n. trc.)
R&S®ZC500		< 13 dB (n. trc.)
RPG ZC750		< 16 dB (n. trc.)
RPG ZC1100		< 16 dB (n. trc.)
Damage level		R&S®ZC75
	R&S®ZC90 and R&S®ZC90E	+20 dBm
	R&S®ZC110	+20 dBm
	R&S®ZC140	+20 dBm
	R&S®ZC170	+20 dBm
	R&S®ZC220	+20 dBm
	RPG ZC260	+10 dBm
	R&S®ZC330	+20 dBm
	RPG ZC400	+10 dBm
	R&S®ZC500	+10 dBm
	RPG ZC750	+5 dBm
	RPG ZC1100	+5 dBm

Source input (RF IN)

Connector type		2.92 mm, female	
Frequency range and multiplication factor	R&S®ZC75	12.500 GHz to 18.750 GHz	× 4
	R&S®ZC90 and R&S®ZC90E	10.000 GHz to 15.000 GHz	× 6
	R&S®ZC110	12.500 GHz to 18.333 GHz	× 6
	R&S®ZC140	15.000 GHz to 23.333 GHz	× 6
	R&S®ZC170	9.167 GHz to 14.167 GHz	× 12
	R&S®ZC220	11.667 GHz to 18.333 GHz	× 12
	RPG ZC260	14.166 GHz to 21.666 GHz	× 12
	R&S®ZC330	12.222 GHz to 18.333 GHz	× 18
	RPG ZC400	14.444 GHz to 22.222 GHz	× 18
	R&S®ZC500	9.027 GHz to 13.889 GHz	× 36
	RPG ZC750	13.888 GHz to 20.833 GHz	× 36
RPG ZC1100	13.888 GHz to 20.370 GHz	× 54	
Input power range		-15 dBm to +10 dBm	

Local oscillator input (LO IN)

Connector type		2.92 mm, female	
Frequency range and multiplication factor	R&S®ZC75	8.287 GHz to 12.454 GHz	× 6
	R&S®ZC90 and R&S®ZC90E	14.930 GHz to 22.430 GHz	× 4
	R&S®ZC110	9.340 GHz to 13.715 GHz	× 8
	R&S®ZC140	11.215 GHz to 17.465 GHz	× 8
	R&S®ZC170	10.972 GHz to 16.972 GHz	× 10
	R&S®ZC220	11.643 GHz to 18.310 GHz	× 12
	RPG ZC260	14.143 GHz to 21.643 GHz	× 12
	R&S®ZC330	9.155 GHz to 13.738 GHz	× 24
	RPG ZC400	12.986 GHz to 19.986 GHz	× 20
	R&S®ZC500	13.530 GHz to 20.822 GHz	× 24
	RPG ZC750	13.881 GHz to 20.826 GHz	× 36
RPG ZC1100	15.619 GHz to 22.911 GHz	× 48	
Input power range		+5 dBm to +10 dBm	

Measurement output (MEAS OUT)

Connector type		SMA, female
Frequency range		5 MHz to 2000 MHz

Reference output (REF OUT)

Connector type		SMA, female
Frequency range		5 MHz to 2000 MHz

USB connector (USB)

Connector type		USB, type B
----------------	--	-------------

Power supply input (POWER SUPPLY)

Connector type		19-pin miniature circular connector with push-pull locking
Power consumption	R&S®ZC75	5 W
	R&S®ZC90 and R&S®ZC90E	11 W
	R&S®ZC110	16 W
	R&S®ZC140	14 W
	R&S®ZC170	12 W
	R&S®ZC220	20 W
	RPG ZC260	12 W
	R&S®ZC330	30 W
	RPG ZC400	10 W
	R&S®ZC500	48 W
	RPG ZC750	30 W
RPG ZC1100	30 W	

System characteristics

Trace stability ³	R&S®ZC75	typ. < 0.1 dB and typ. < 1.5°
	R&S®ZC90 and R&S®ZC90E	typ. < 0.1 dB and typ. < 1.5°
	R&S®ZC110	typ. < 0.1 dB and typ. < 1.5°
	R&S®ZC140	typ. < 0.15 dB and typ. < 2°
	R&S®ZC170	typ. < 0.3 dB and typ. < 4°
	R&S®ZC220	typ. < 0.3 dB and typ. < 4°
	RPG ZC260	typ. < 0.4 dB and typ. < 4°
	R&S®ZC330	typ. < 0.4 dB and typ. < 6°
	RPG ZC400	typ. < 0.5 dB and typ. < 6°
	R&S®ZC500	typ. < 0.5 dB and typ. < 6°
	RPG ZC750	typ. < 0.5 dB and typ. < 6°
RPG ZC1100	typ. < 0.5 dB and typ. < 6°	
Source match (without system error correction)	non-traceable specifications with limits (n. trc.)	
	R&S®ZC75	> 25 dB (n. trc.)
	R&S®ZC90 and R&S®ZC90E	> 25 dB (n. trc.)
	R&S®ZC110	> 25 dB (n. trc.)
	R&S®ZC140	> 25 dB (n. trc.)
	R&S®ZC170	> 25 dB (n. trc.)
	R&S®ZC220	> 25 dB (n. trc.)
	RPG ZC260	> 20 dB (n. trc.)
	R&S®ZC330	> 20 dB (n. trc.)
	RPG ZC400	> 20 dB (n. trc.)
	R&S®ZC500	> 20 dB (n. trc.)
RPG ZC750	> 15 dB (n. trc.)	
RPG ZC1100	> 15 dB (n. trc.)	
Directivity (without system error correction)	non-traceable specifications with limits (n. trc.)	
	R&S®ZC75	> 25 dB (n. trc.)
	R&S®ZC90 and R&S®ZC90E	> 30 dB (n. trc.)
	R&S®ZC110	> 25 dB (n. trc.)
	R&S®ZC140	> 25 dB (n. trc.)
	R&S®ZC170	> 25 dB (n. trc.)
	R&S®ZC220	> 25 dB (n. trc.)
	RPG ZC260	> 20 dB (n. trc.)
	R&S®ZC330	> 20 dB (n. trc.)
	RPG ZC400	> 20 dB (n. trc.)
	R&S®ZC500	> 20 dB (n. trc.)
RPG ZC750	> 15 dB (n. trc.)	
RPG ZC1100	> 10 dB (n. trc.)	
Effective source match (with system error correction)	R&S®ZC75	> 35 dB (meas.)
	R&S®ZC90 and R&S®ZC90E	> 35 dB (meas.)
	R&S®ZC110	> 35 dB (meas.)
	R&S®ZC140	> 30 dB (meas.)
	R&S®ZC170	> 30 dB (meas.)
	R&S®ZC220	> 30 dB (meas.)
	RPG ZC260	> 30 dB (meas.)
	R&S®ZC330	> 30 dB (meas.)
	RPG ZC400	> 30 dB (meas.)
	R&S®ZC500	> 30 dB (meas.)
	RPG ZC750	> 25 dB (meas.)
RPG ZC1100	> 25 dB (meas.)	

³ Trace stability is defined as the maximum deviation of the max. or min. hold trace of the reflection factor from its initial (reference) trace when measuring a converter whose waveguide port is terminated with a short. The data is valid if the ambient temperature of the R&S®ZNA/R&S®ZVA and the converter has not changed by more than 1 K over 1 h, the output power of the converter is unattenuated and the measurement bandwidth is set to 100 Hz.

Effective directivity (with system error correction)	R&S®ZC75	> 35 dB (meas.)
	R&S®ZC90 and R&S®ZC90E	> 35 dB (meas.)
	R&S®ZC110	> 35 dB (meas.)
	R&S®ZC140	> 30 dB (meas.)
	R&S®ZC170	> 30 dB (meas.)
	R&S®ZC220	> 30 dB (meas.)
	RPG ZC260	> 30 dB (meas.)
	R&S®ZC330	> 27 dB (meas.)
	RPG ZC400	> 27 dB (meas.)
	R&S®ZC500	> 23 dB (meas.)
	RPG ZC750	> 23 dB (meas.)
	RPG ZC1100	> 17 dB (meas.)
	Dynamic range ^{4,5}	R&S®ZC75
R&S®ZC90		> 110 dB, typ. 120 dB
R&S®ZC90E		> 105 dB, typ. 118 dB
R&S®ZC110		> 110 dB, typ. 120 dB
R&S®ZC140		> 105 dB, typ. 120 dB
R&S®ZC170		> 90 dB, typ. 105 dB
R&S®ZC220		> 100 dB, typ. 115 dB
RPG ZC260		> 100 dB, typ. 110 dB
R&S®ZC330		> 100 dB, typ. 115 dB
RPG ZC400		> 80 dB, typ. 95 dB
R&S®ZC500		> 85 dB, typ. 105 dB
RPG ZC750		> 80 dB, typ. 90 dB
RPG ZC1100		> 60 dB, typ. 75 dB

⁴ Dynamic range is defined as the difference between the data trace of the transmission magnitude with maximum test port output power and both test ports through-connected on the one hand and the RMS value of the data trace of the transmission magnitude produced by noise and crosstalk with the test ports short-circuited on the other hand. The specification is valid without system error correction and at 10 Hz measurement bandwidth.

The dynamic range can be increased by using a measurement bandwidth of 1 Hz.

⁵ Dynamic range is specified using one of the following R&S®ZVA models: R&S®ZVA24 (model .28), R&S®ZVA40 (model .48), R&S®ZVA67 (model .02 or model .04). The dynamic range may be effectively reduced for other R&S®ZVAxx models.

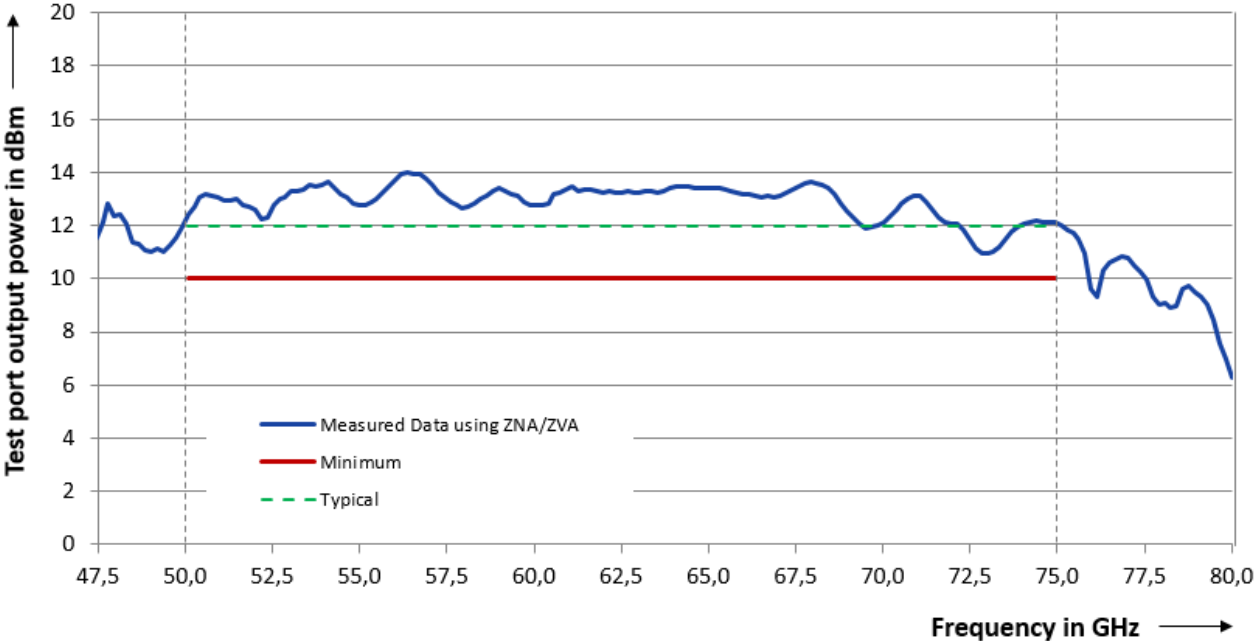

Test port output power versus frequency of the R&S®ZC75

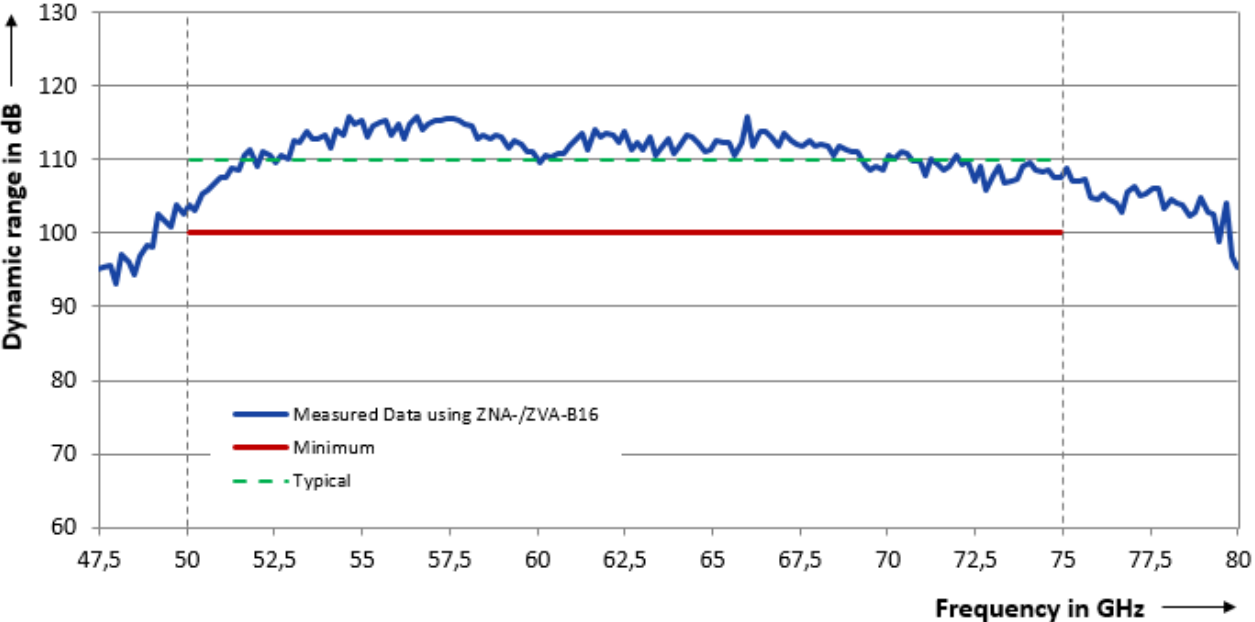

Dynamic range versus frequency of the R&S®ZC75

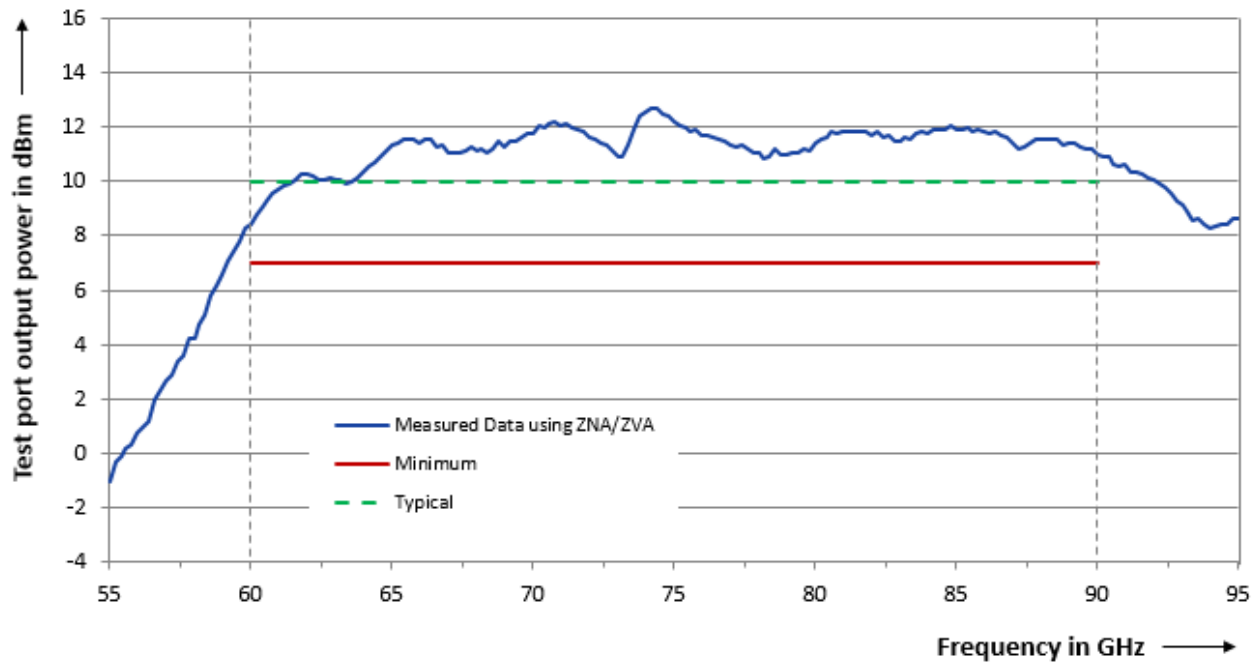

Test port output power versus frequency of the R&S®ZC90

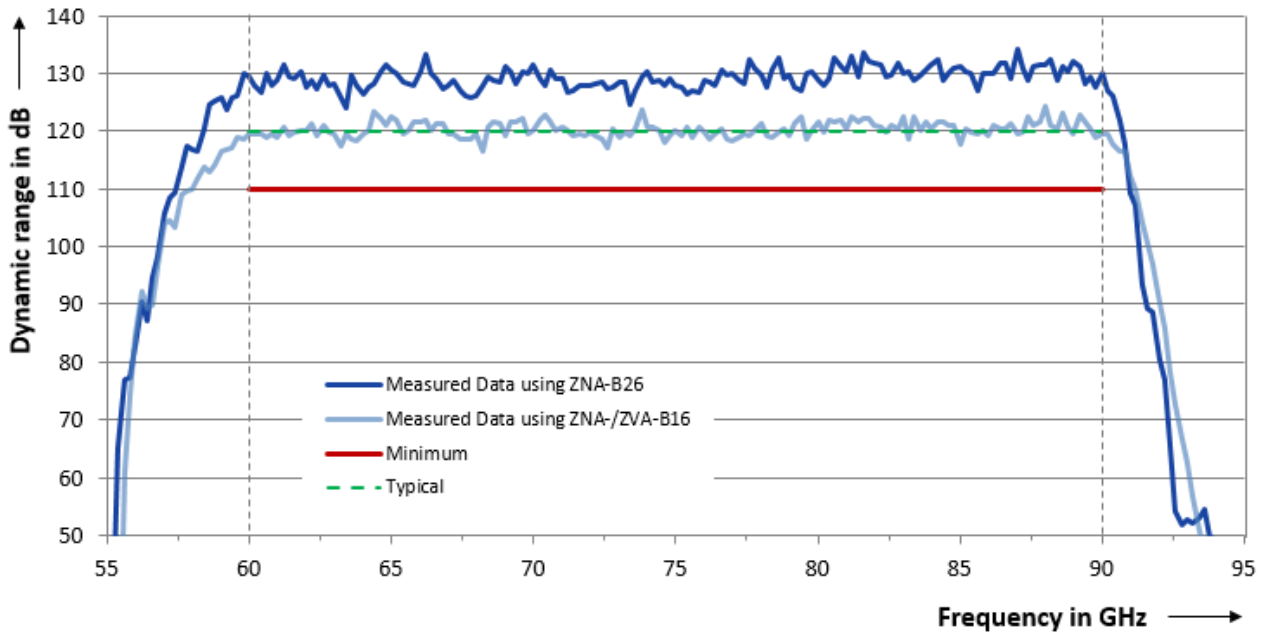

Dynamic range versus frequency of the R&S®ZC90

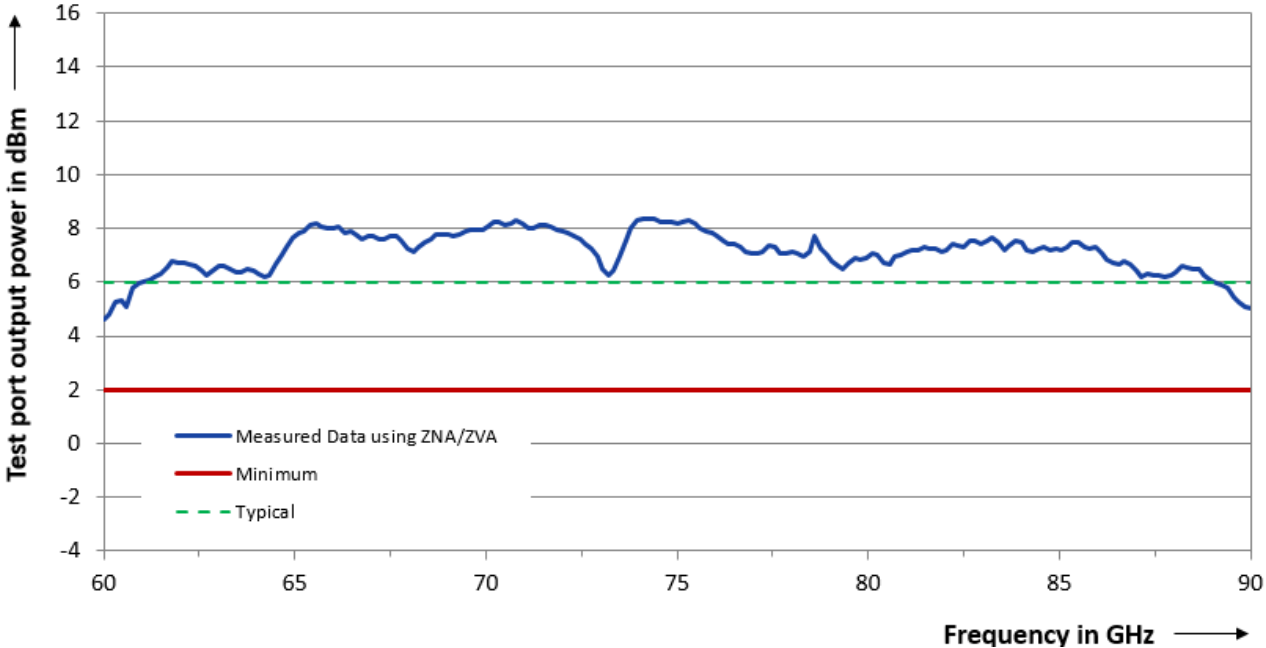

Test port output power versus frequency of the R&S ZC90E

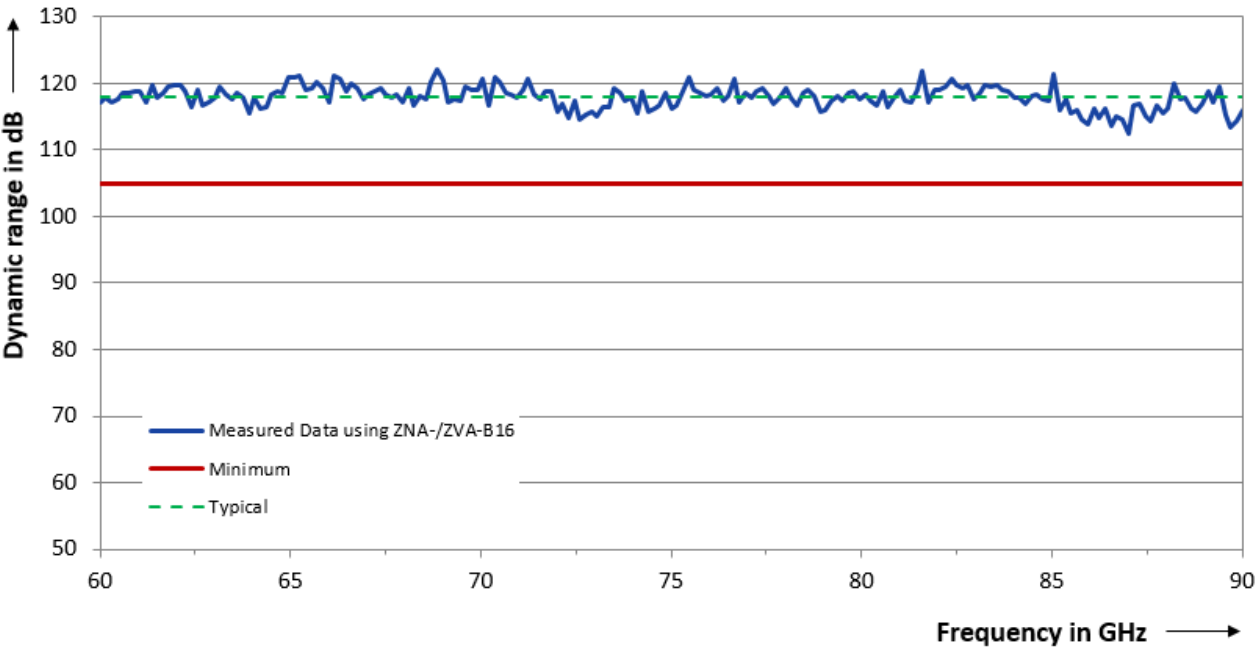

Dynamic range versus frequency of the R&S ZC90E

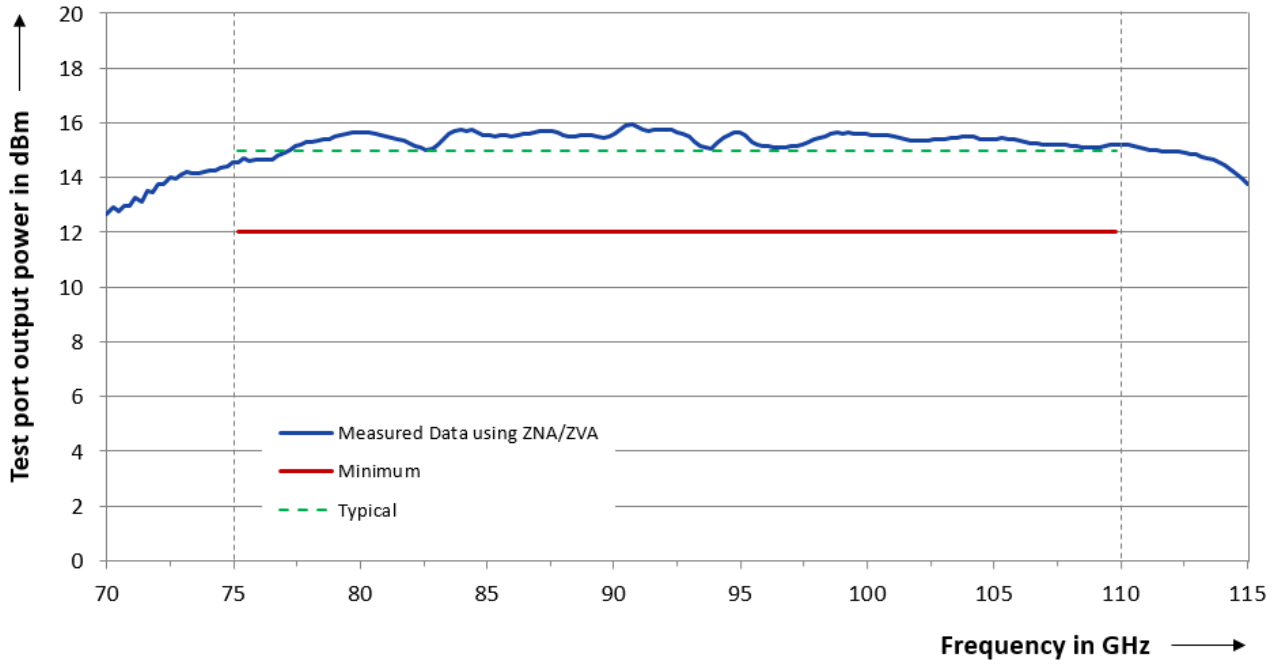

Test port output power versus frequency of the R&S®ZC110

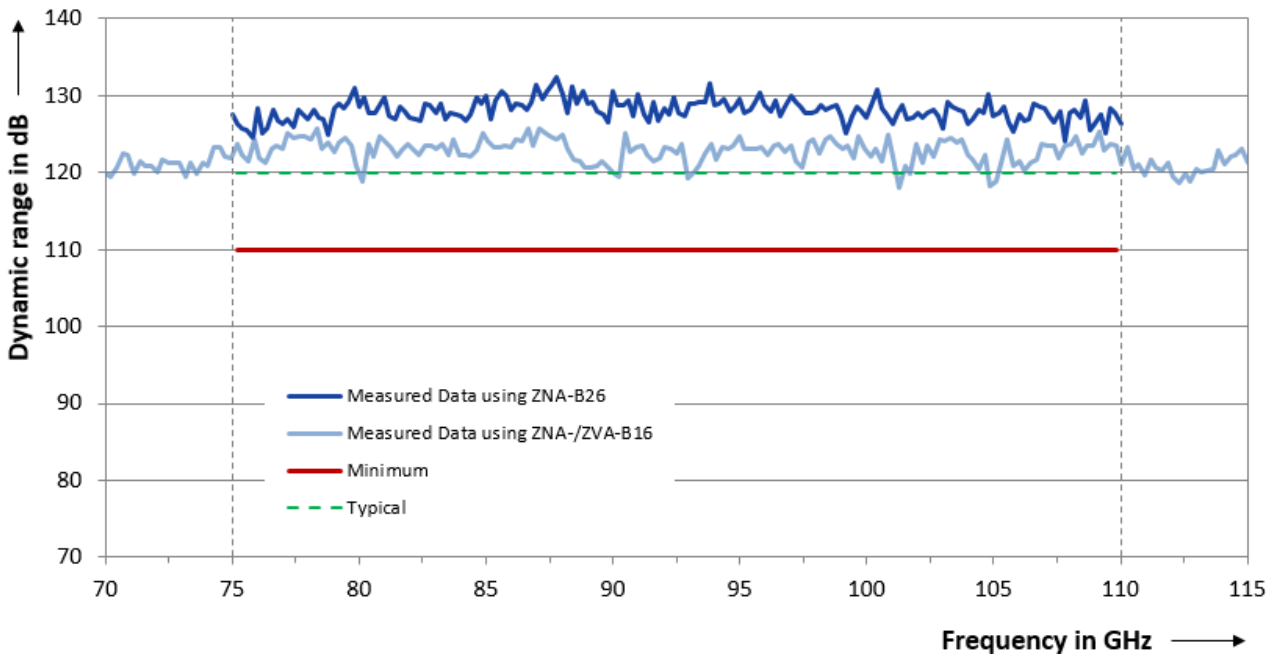

Dynamic range versus frequency of the R&S®ZC110

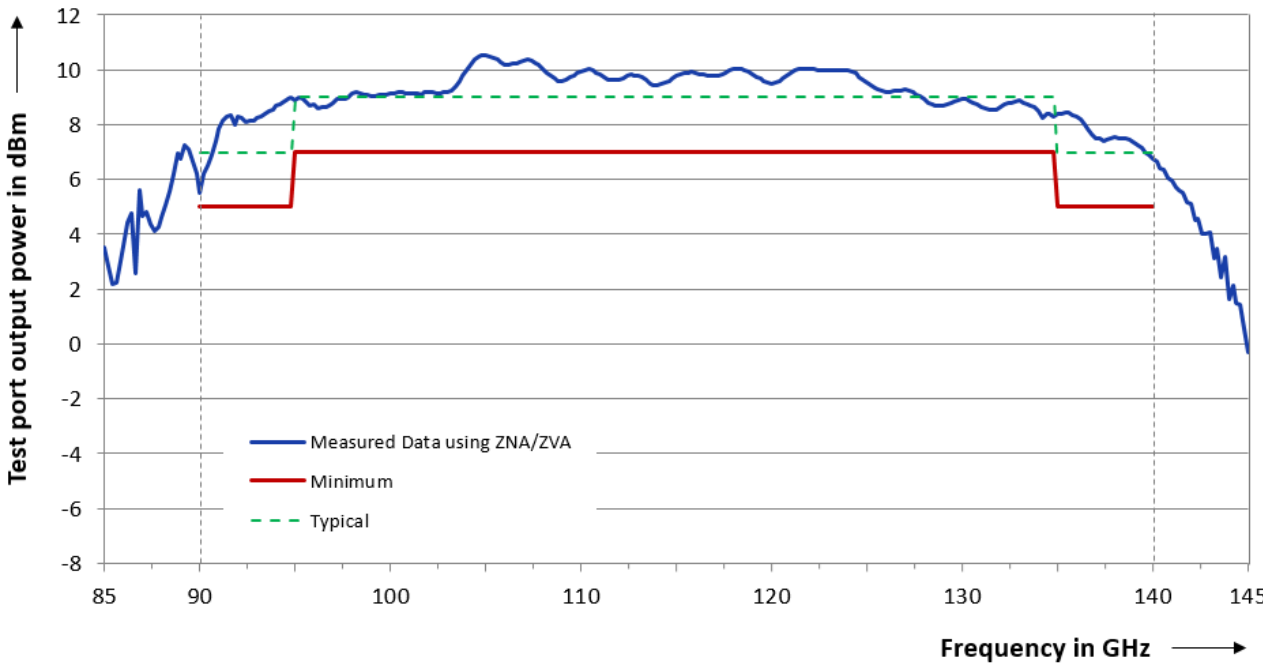

Test port output power versus frequency of the R&S[®]ZC140

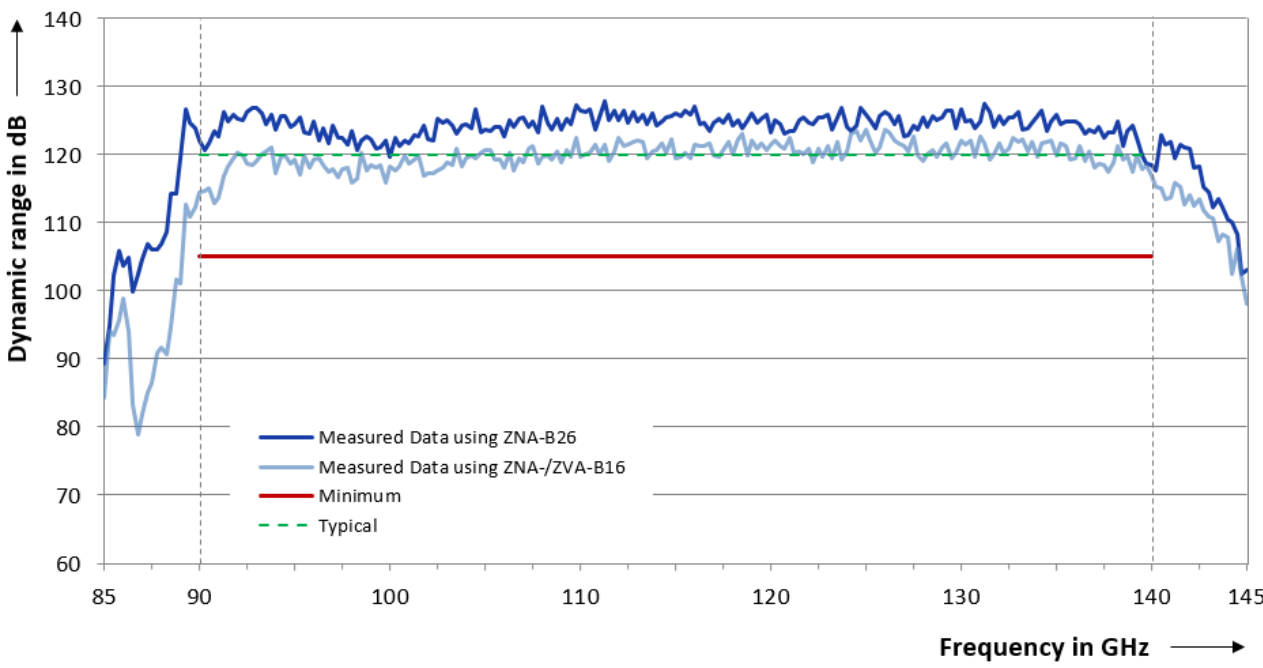

Dynamic range versus frequency of the R&S[®]ZC140

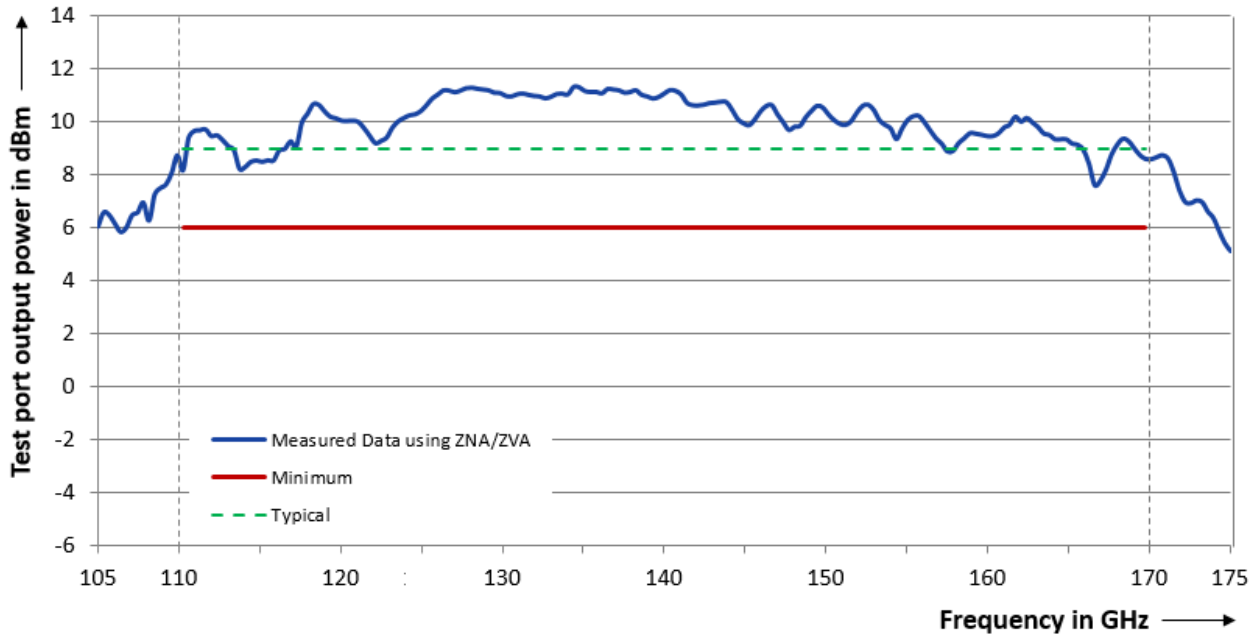

Test port output power versus frequency of the R&S[®]ZC170

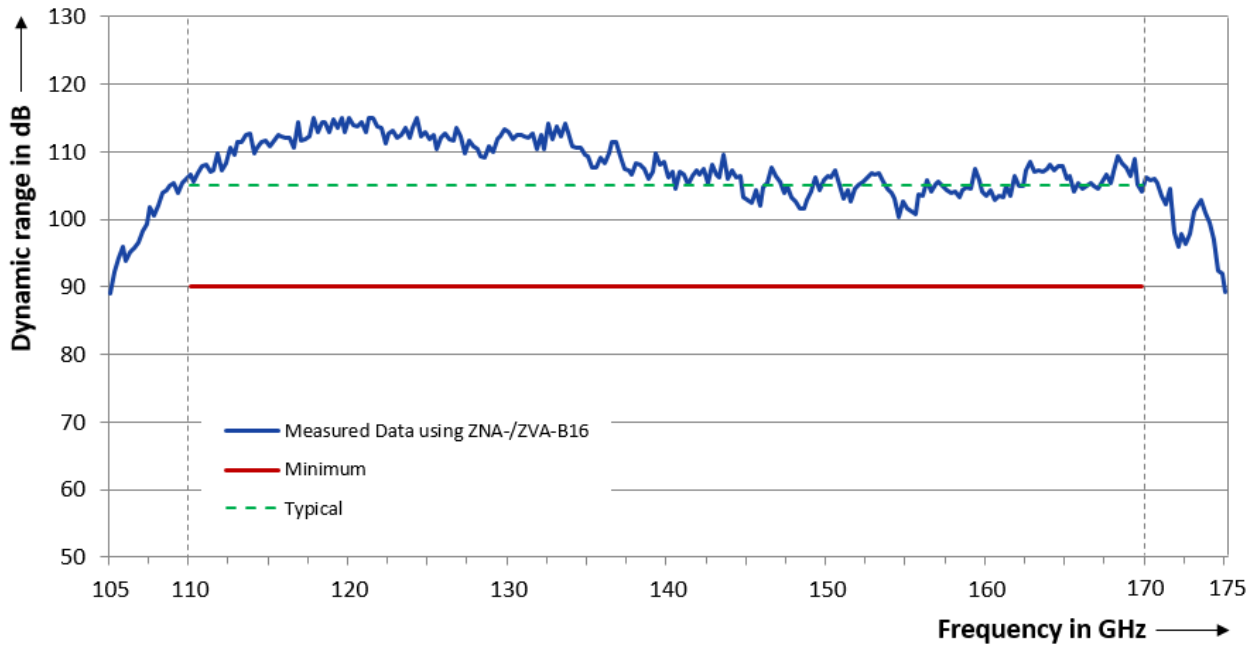

Dynamic range versus frequency of the R&S[®]ZC170

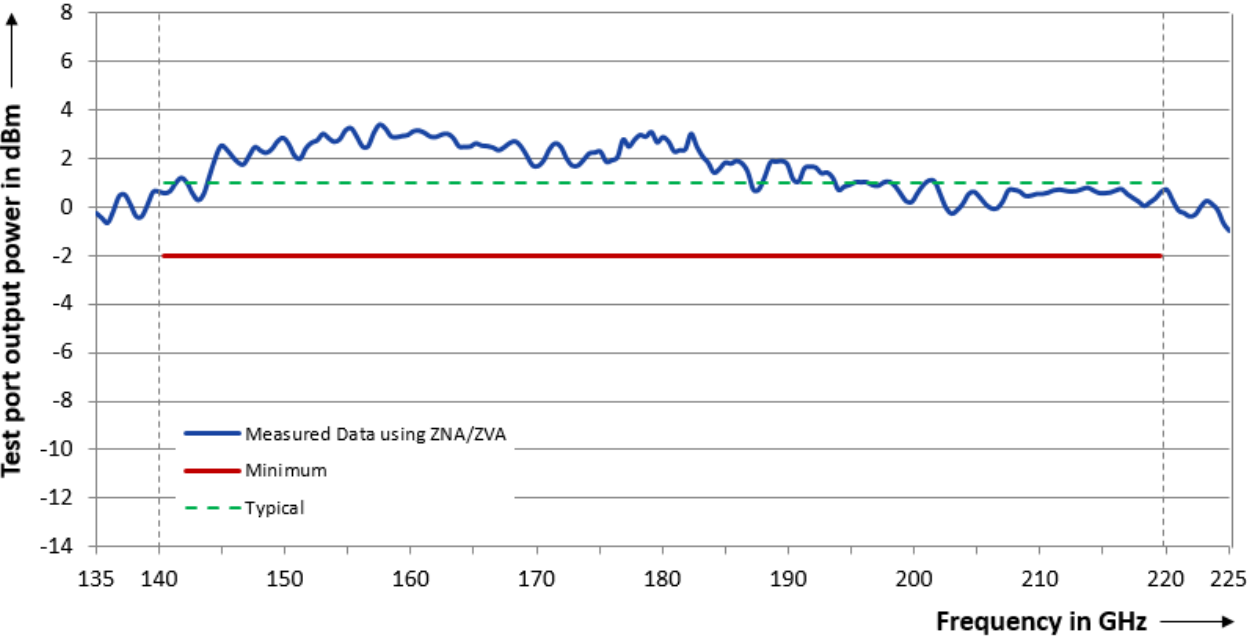

Test port output power versus frequency of the R&S ZC220

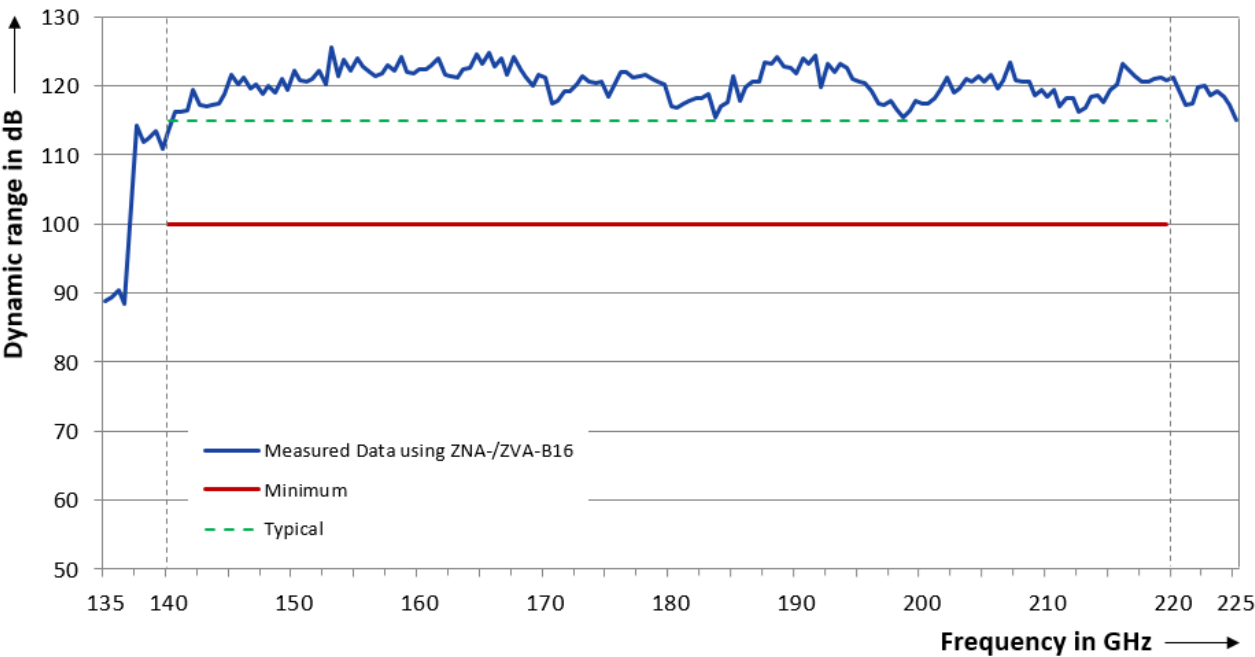

Dynamic range versus frequency of the R&S ZC220

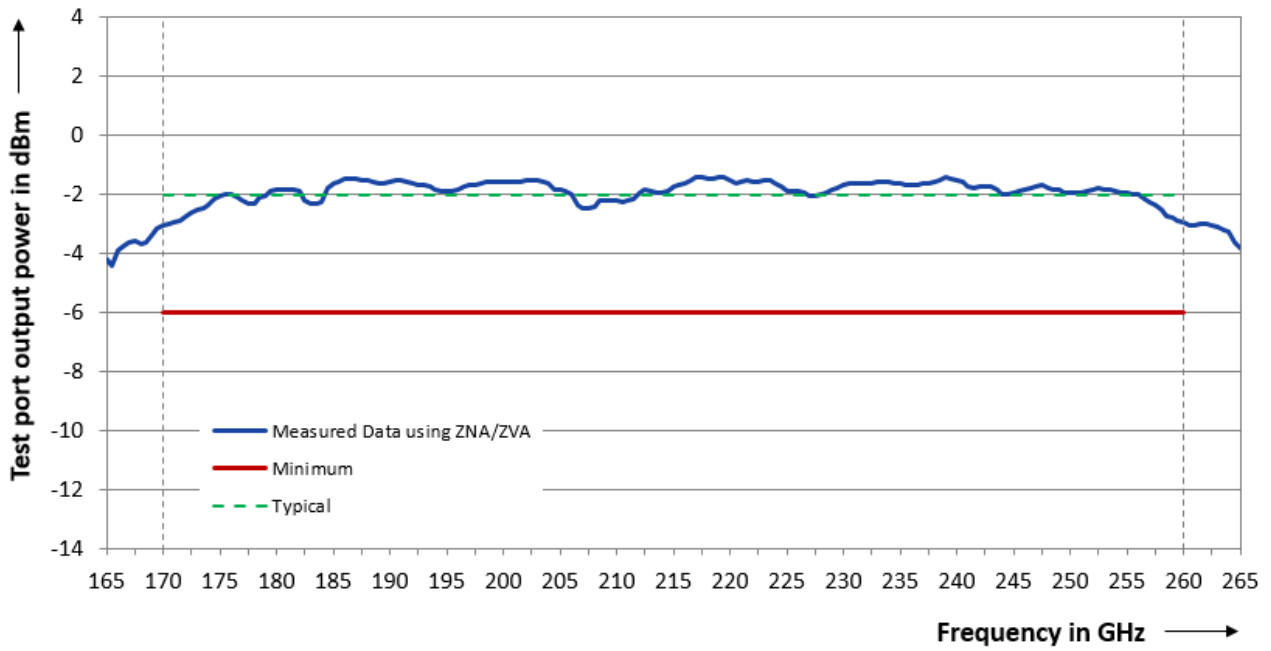

Test port output power versus frequency of the RPG ZC260

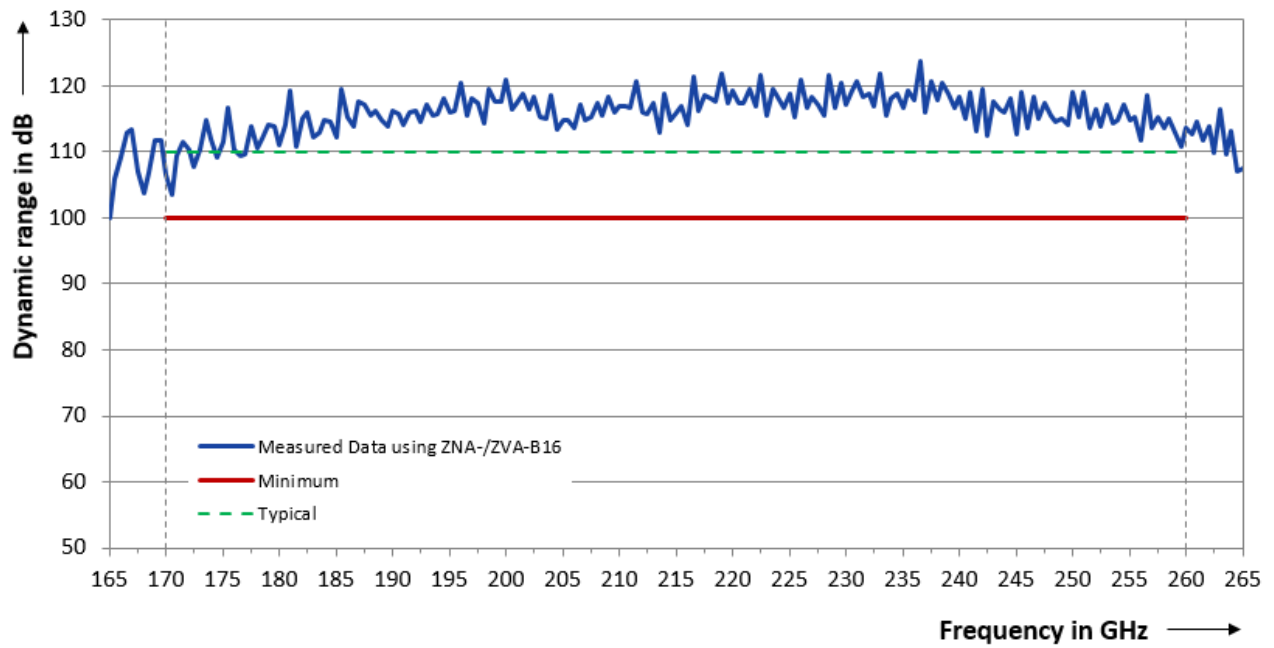

Dynamic range versus frequency of the RPG ZC260

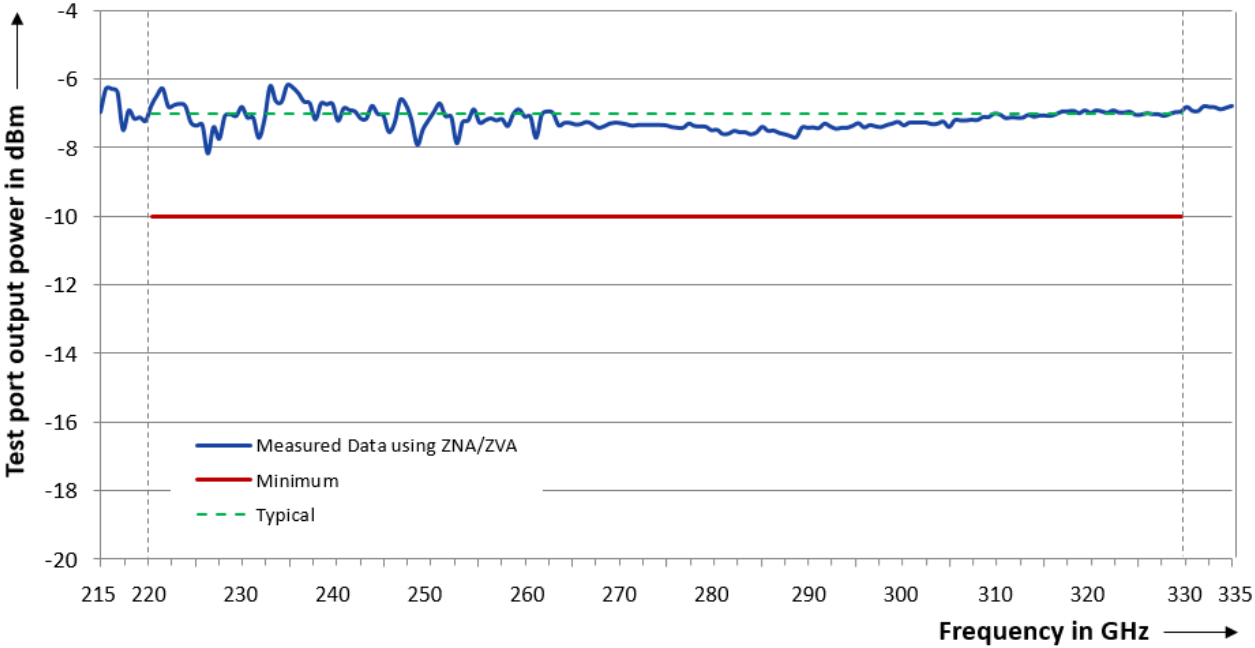

Test port output power versus frequency of the R&S®ZC330

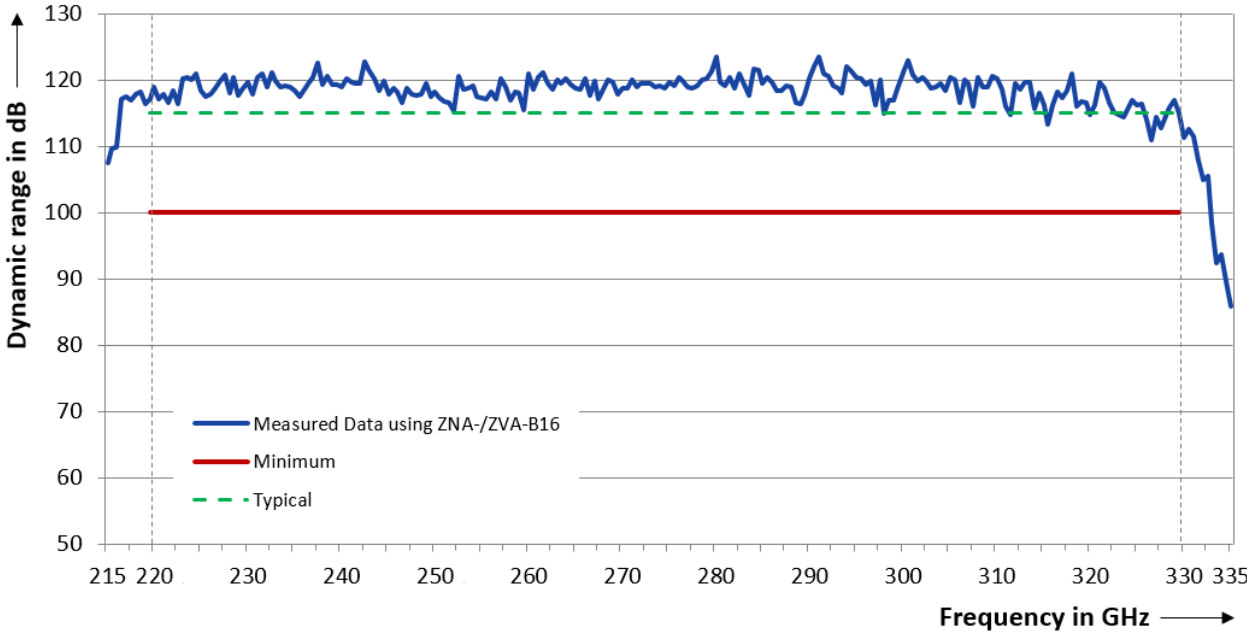

Dynamic range versus frequency of the R&S®ZC330

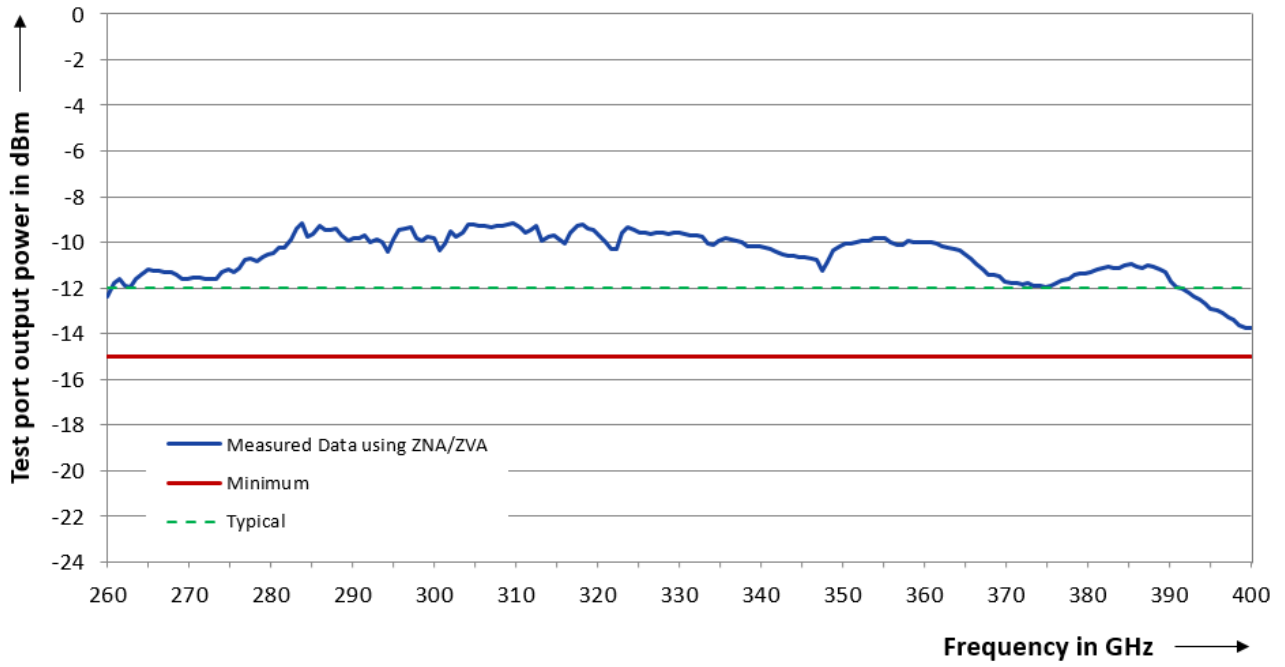

Test port output power versus frequency of the RPG ZC400

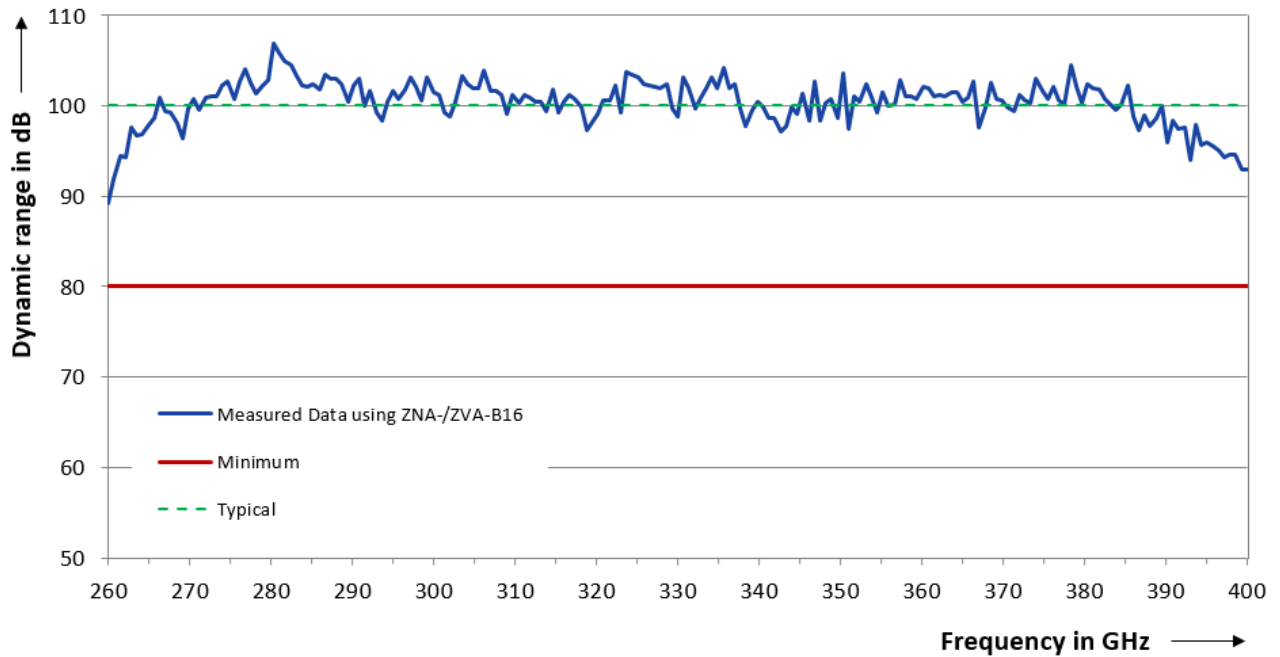

Dynamic range versus frequency of the RPG ZC400

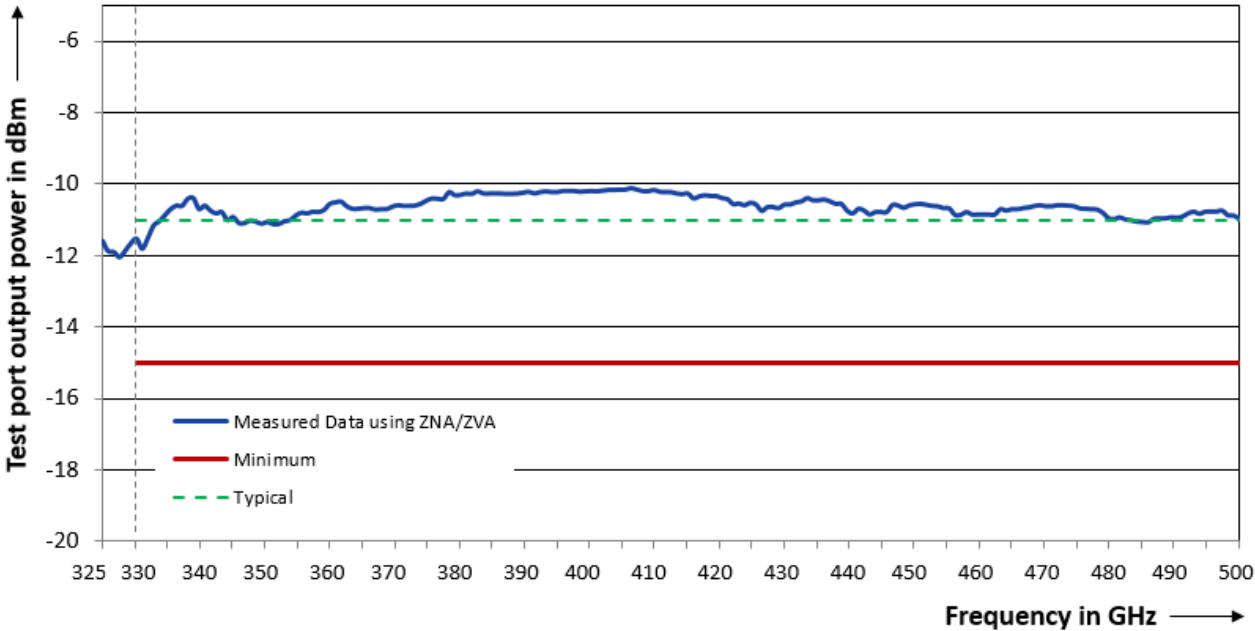

Test port output power versus frequency of the R&S ZC500

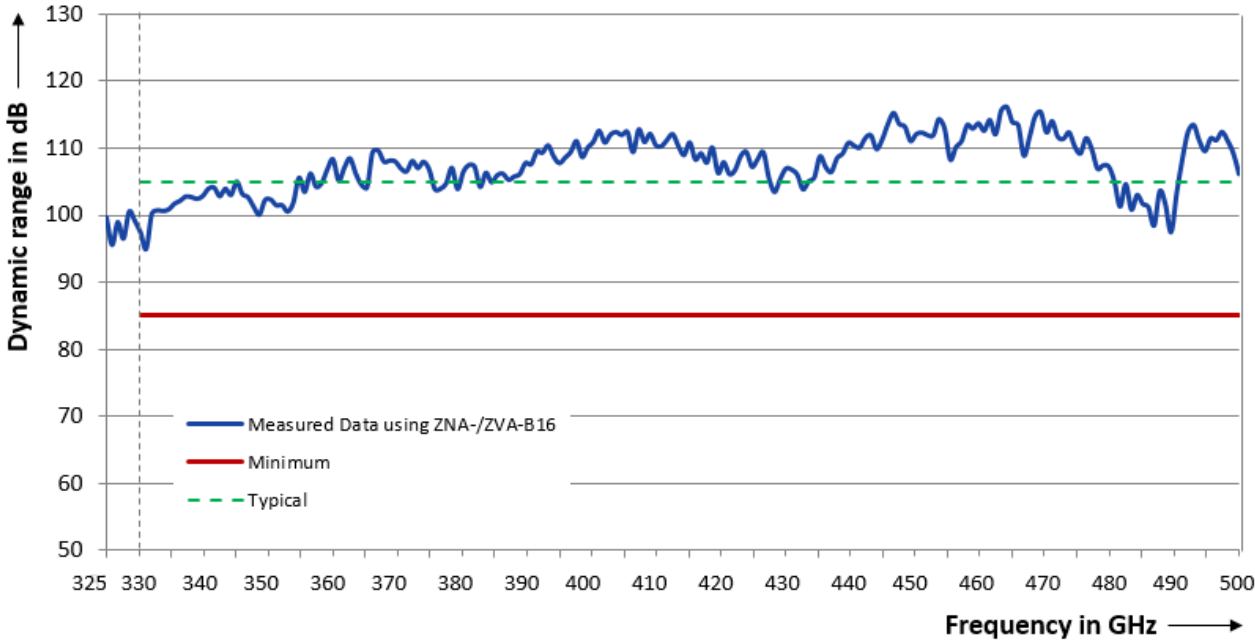

Dynamic range versus frequency of the R&S ZC500

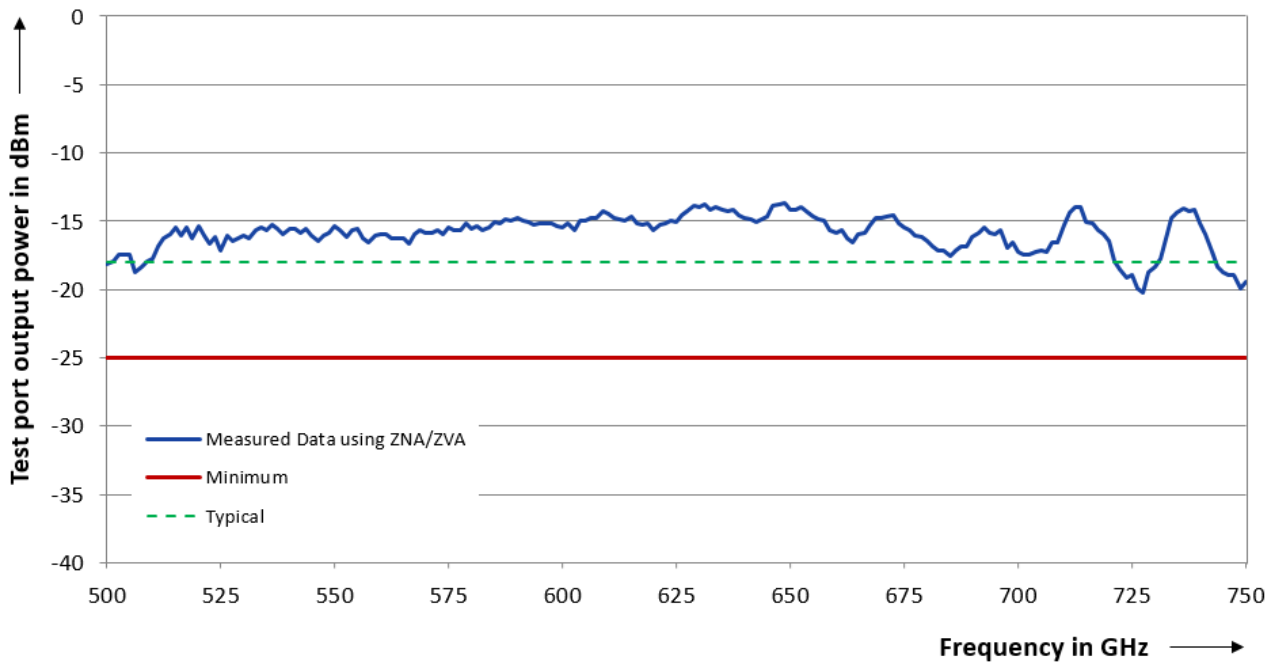

Test port output power versus frequency of the RPG ZC750

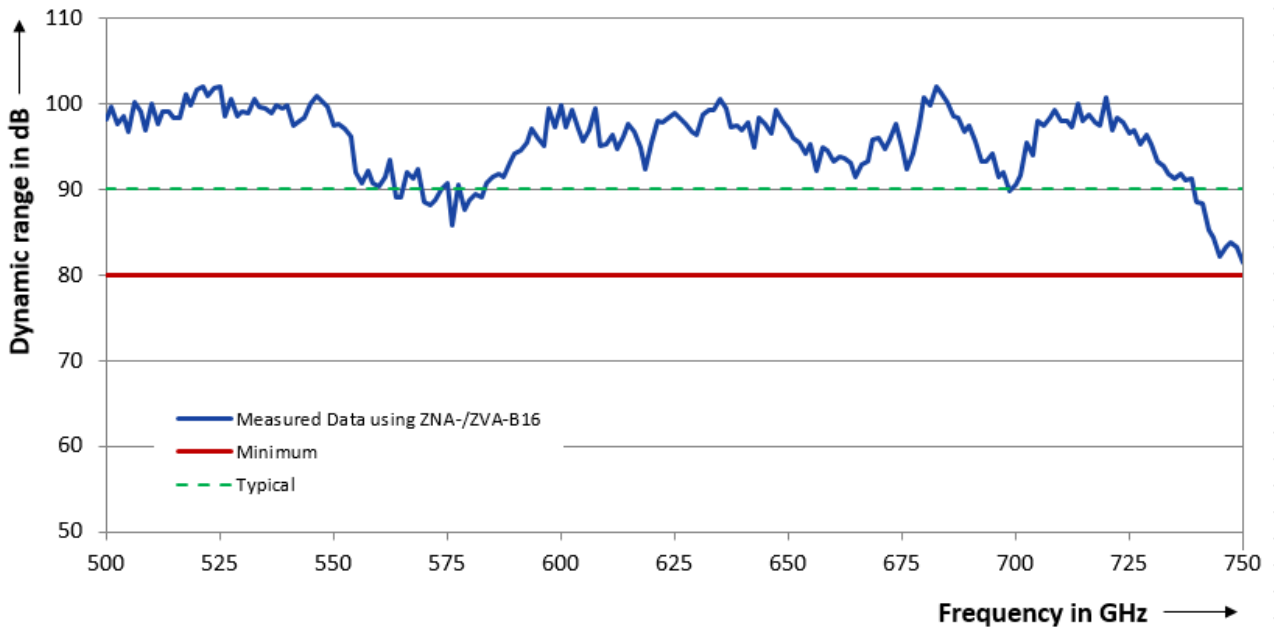

Dynamic range versus frequency of the RPG ZC750

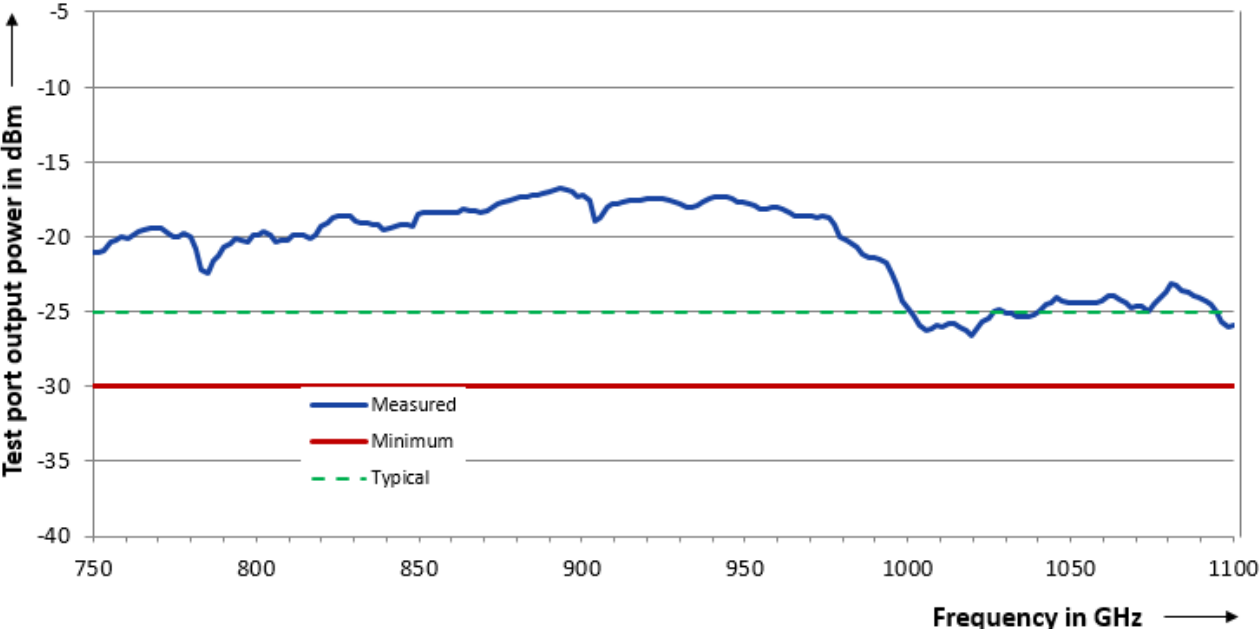

Test port output power versus frequency of the RPG ZC1100

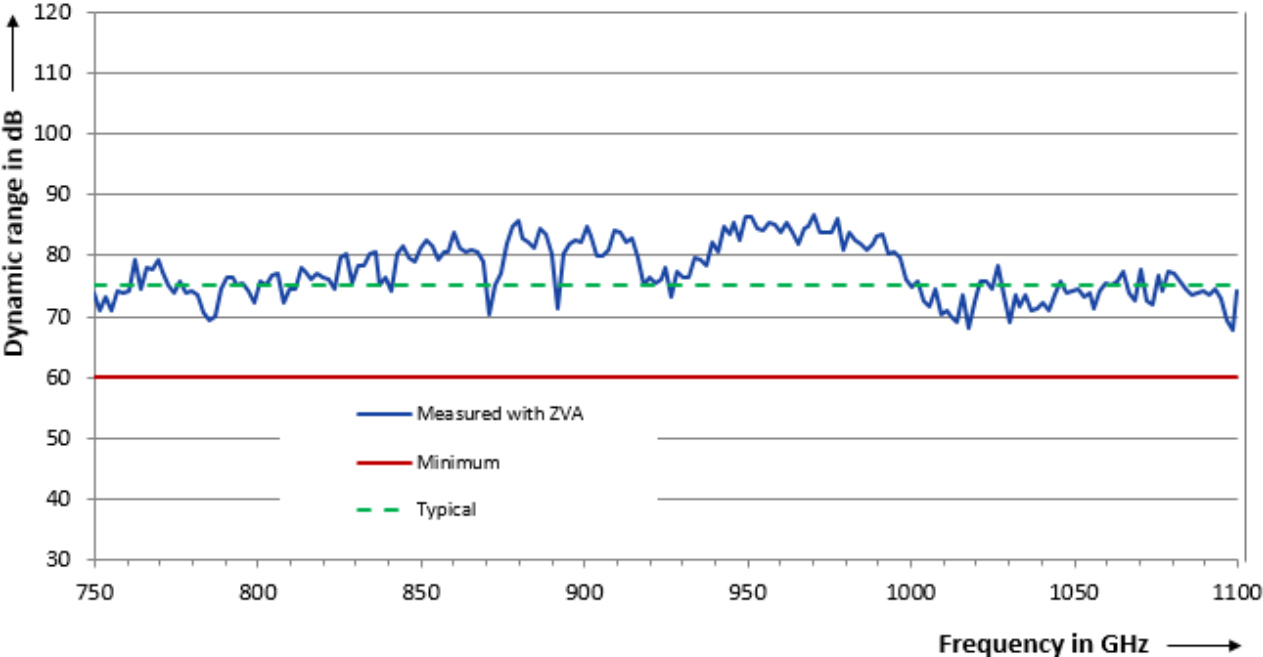

Dynamic range versus frequency of the RPG ZC1100

General data

Temperature loading	operating temperature range	+18 °C to +28 °C
	permissible temperature range	+5 °C to +40 °C
	storage temperature range	-40 °C to +70 °C
Damp heat		in line with IEC 60068-2-1 and IEC 60068-2-2
		+40 °C at 80 % rel. humidity, in line with IEC 60068-2-30
Mechanical resistance	vibration, sinusoidal	5 Hz to 150 Hz, in line with IEC 60068-2-6
	vibration, random	10 Hz to 300 Hz, in line with IEC 60068-2-64
	shock	40 g shock spectrum, in line with MIL-STD-810, method 516, procedure I
Operation	permissible altitude	3000 m above sea level
Dimensions (W × H × D)	without protruding coupler and test port adapter, with feet height adjusted to 12.1 mm (0.5 in), see also dimensional drawings on the next two pages	
	R&S®ZC90, R&S®ZC110	123 mm × 88.4 mm × 228.3 mm (4.84 in × 3.48 in × 8.99 in)
	R&S®ZC75, R&S®ZC90E, R&S®ZC140, R&S®ZC170, R&S®ZC220, RPG ZC260, R&S®ZC330, RPG ZC400, R&S®ZC500, RPG ZC750, RPG ZC1100	123 mm × 88.4 mm × 288.3 mm (4.84 in × 3.48 in × 11.35 in)
Number of feet		4
Feet height	user-adjustable	12.1 mm to 29.1 mm (0.5 in to 1.1 in)
Weight		3 kg (7 lb)
Shipping weight		5 kg (11 lb)

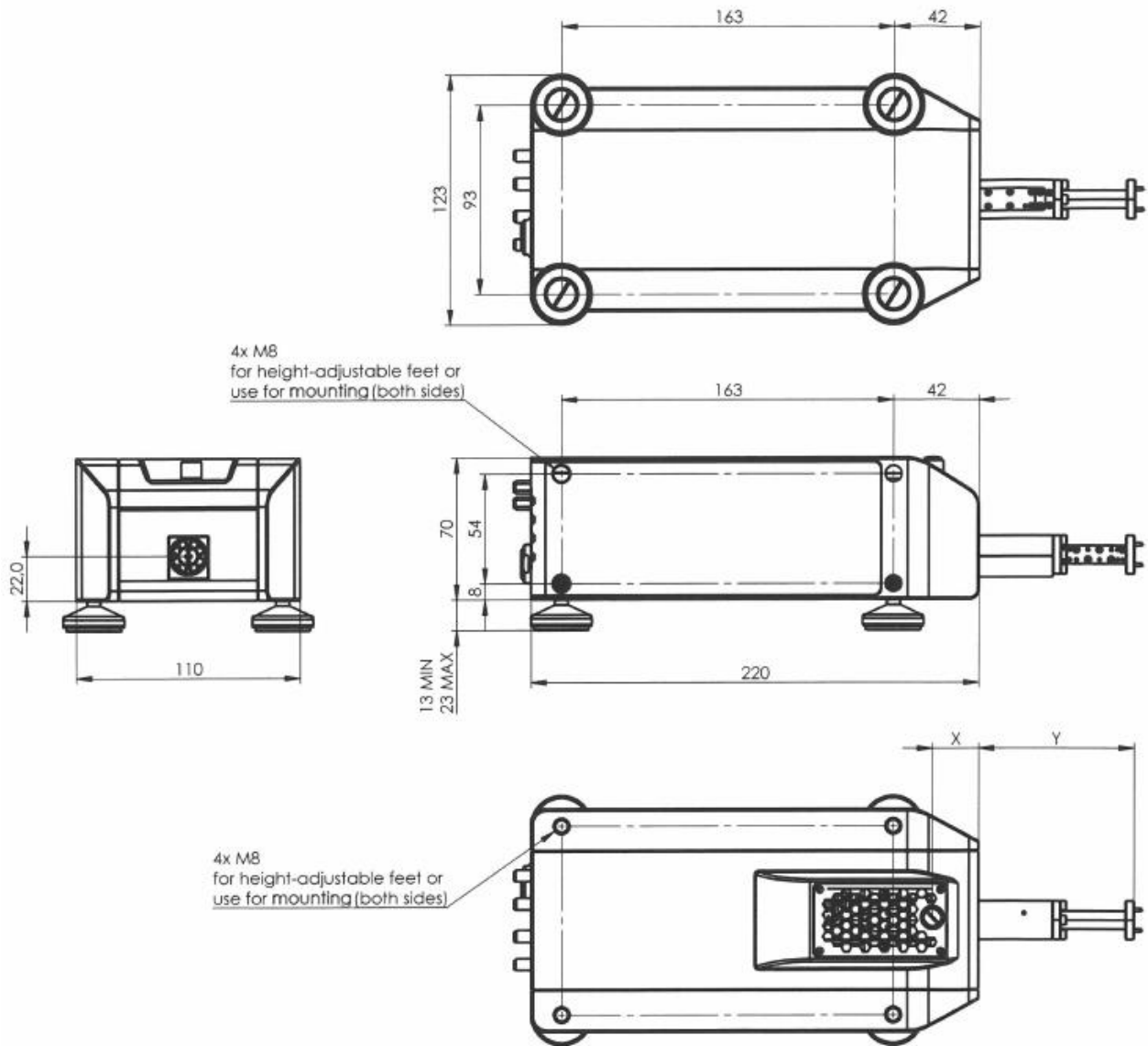

Dimensions (in mm) of the R&S®ZCxxx millimeterwave converters

Type	Waveguide	Dimension X (distance between converter front panel and center of attenuator screw)	Dimension Y (distance between converter front panel and waveguide flange surface)
R&S®ZC90	WR12	N/A	83.0 mm
R&S®ZC110	WM-2540 (WR10)	N/A	76.5 mm

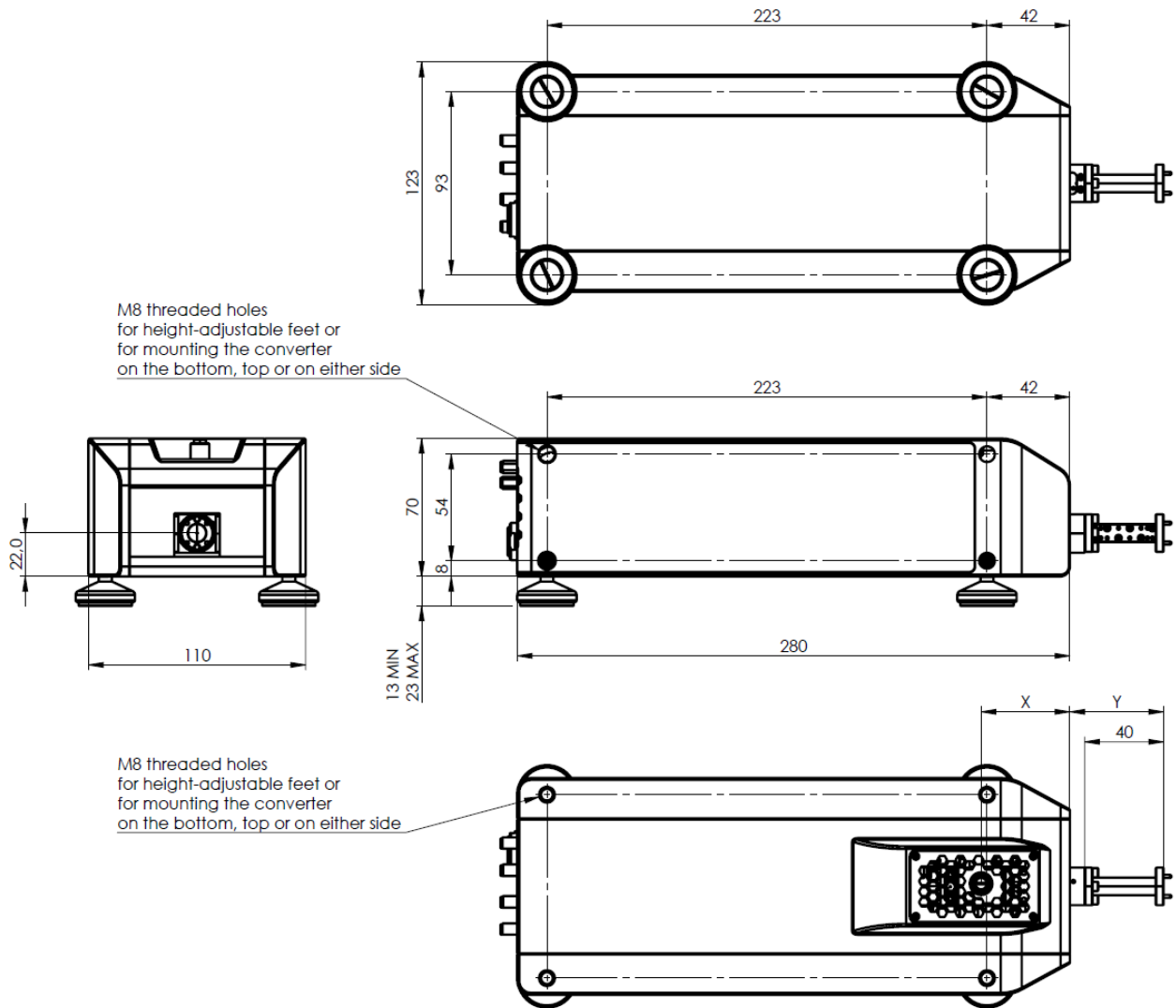

Dimensions (in mm) of the R&S®ZCxxx/RPG ZCxxx millimeterwave converters

Type	Waveguide	Dimension X (distance between converter front panel and center of attenuator screw)	Dimension Y (distance between converter front panel and waveguide flange surface)
R&S®ZC75	WR15	70.1 mm	70.5 mm
R&S®ZC90E	WR12	N/A	83.0 mm
R&S®ZC140	WM-2032 (WR8.0)	70.0 mm	64.5 mm
R&S®ZC170	WM-1651 (WR6.5)	68.1 mm	64.4 mm
R&S®ZC220	WM-1295 (WR5.1)	61.9 mm	59.5 mm
RPG ZC260	WM-1092 (WR4.3)	52.0 mm	65.5 mm
R&S®ZC330	WM-864 (WR3.4)	45.0 mm	47.5 mm
RPG ZC400	WM-710	52.0 mm	50.5 mm
R&S®ZC500	WM-570	34.0 mm	46.5 mm
RPG ZC750	WM-380	28.5 mm	43.5 mm
RPG ZC1100	WM-250	N/A	25.5 mm

Ordering information

Designation	Type	Order No.
Millimeterwave converter WR15	R&S®ZC75	1323.8259.02
Millimeterwave converter WR12	R&S®ZC90	1323.7600.02
Millimeterwave converter WR12 EL ATT	R&S®ZC90E	1323.7600.04
Millimeterwave converter WM-2540	R&S®ZC110	1323.7617.02
Millimeterwave converter WM-2032	R&S®ZC140	1323.7623.02
Millimeterwave converter WM-1651	R&S®ZC170	1323.7630.02
Millimeterwave converter WM-1295	R&S®ZC220	1323.7646.02
Millimeterwave converter WM-1092	RPG ZC260	3628.5682.02
Millimeterwave converter WM-864	R&S®ZC330	1323.7669.02
Millimeterwave converter WM-710	RPG ZC400	3656.9220.02
Millimeterwave converter WM-570	R&S®ZC500	1323.7681.02
Millimeterwave converter WM-380	RPG ZC750	1323.7717.02
Millimeterwave converter WM-250	RPG ZC1100	1323.7723.02
Millimeterwave converter set transport case	R&S®ZCSTC	1323.7730.00
Millimeterwave converter power supply (supplies two converters)	R&S®ZCPS	1325.6101.02
Long cable for R&S®ZCPS (length: 160 cm, 40 cm longer than the standard DC connection cable delivered with each converter)	R&S®ZCPSC	1323.7952.00
Test cable, 3.5 mm (f) to 3.5 mm (m), length: 910 mm (two cables per converter required)	R&S®ZV-Z193	1306.4520.36
Test cable, 2.92 mm (f) to 2.92 mm (m), length: 910 mm (two cables per converter required)	R&S®ZV-Z195	1306.4536.36
Waveguide calibration kit WR15 (without sliding match)	R&S®ZV-WR15	1307.7500.30
Waveguide calibration kit WR15 (with sliding match)	R&S®ZV-WR15	1307.7500.31
Waveguide calibration kit WR12 (without sliding match),	R&S®ZV-WR12	1307.7700.10
Waveguide calibration kit WR12 (with sliding match),	R&S®ZV-WR12	1307.7700.11
Waveguide calibration kit WR10 (without sliding match), compatible with converter WM-2540	R&S®ZV-WR10	1307.7100.10
Waveguide calibration kit WR10 (with sliding match), compatible with converter WM-2540	R&S®ZV-WR10	1307.7100.11
Waveguide calibration kit WR08 (without sliding match), compatible with converter WM-2032	R&S®ZV-WR08	1307.7900.10
Waveguide calibration kit WR08 (with sliding match), compatible with converter WM-2032	R&S®ZV-WR08	1307.7900.11
Waveguide calibration kit WR06 (without sliding match), compatible with converter WM-1651	R&S®ZV-WR06	1311.8807.10
Waveguide calibration kit WR06 (with sliding match), compatible with converter WM-1651	R&S®ZV-WR06	1311.8807.11
Waveguide calibration kit WR05 (without sliding match), compatible with converter WM-1295	R&S®ZV-WR05	1307.8106.10
Waveguide calibration kit WR05 (with sliding match), compatible with converter WM-1295	R&S®ZV-WR05	1307.8106.11
Waveguide calibration kit WM-1092 (without sliding match)	RPG ZCWM-1092	3628.5699.02
Waveguide calibration kit WR03 (without sliding match), compatible with converter WM-864	R&S®ZV-WR03	1307.7300.30
Waveguide calibration kit WR03 (with sliding match), compatible with converter WM-864	R&S®ZV-WR03	1307.7300.31
Waveguide calibration kit WM-710 (without sliding match)	RPG ZCWM-710	1339.4070.02
Waveguide calibration kit WM-570 (without sliding match)	R&S®ZCWM-570	1322.3099.10
Waveguide calibration kit WM-380 (without sliding match)	RPG ZCWM-380	1322.3101.02
Waveguide calibration kit WM-250 (without sliding match)	RPG ZCWM-250	1322.3118.02
Converter control software	R&S®ZVA-K8	1307.7022.02
Adapter kit, including a power divider and two right angle SMA (m/m) adapters (required if R&S®ZVA24 model .28 or R&S®ZVA40 model .48 (VNAs with four sources) is used)	R&S®ZCAK	1323.7746.24
Adapter kit, including four 1.85 mm (f) to 2.92 mm (m) adapters and four 1.85 mm (m) to 2.92 mm (f) adapters (required if R&S®ZVA50 is used)	R&S®ZCAK	1323.7746.50
Adapter kit, including a power divider, two right angle SMA (m/m) adapters, three 1.85 mm (f) to 2.92 mm (m) adapters and four 1.85 mm (m) to 2.92 mm (f) adapters (required if R&S®ZVA67 is used)	R&S®ZCAK	1323.7746.67
Torque wrench, for waveguide flange screws	R&S®ZV-Z1000	1314.5467.02
Angled wrench, for waveguide flange screws	R&S®ZCAW	1175.1960.00
Angled torque wrench, for waveguide flange screws, 0.58 Nm	R&S®ZCTW	1175.2014.02
Angled torque wrench, for waveguide flange screws, 0.2 Nm	R&S®ZCTW	1175.2014.03

Service options		
Extended warranty, one year	R&S®WE1	Please contact your local Rohde & Schwarz sales office.
Extended warranty, two years	R&S®WE2	
Extended warranty, three years	R&S®WE3	
Extended warranty, four years	R&S®WE4	
Extended warranty with calibration coverage, one year	R&S®CW1	
Extended warranty with calibration coverage, two years	R&S®CW2	
Extended warranty with calibration coverage, three years	R&S®CW3	
Extended warranty with calibration coverage, four years	R&S®CW4	

Extended warranty with a term of one to four years (WE1 to WE4)

Repairs carried out during the contract term are free of charge ⁶. Necessary calibration and adjustments carried out during repairs are also covered.

Extended warranty with calibration (CW1 to CW4)

Enhance your extended warranty by adding calibration coverage at a package price. This package ensures that your Rohde & Schwarz product is regularly calibrated, inspected and maintained during the term of the contract. It includes all repairs ⁶ and calibration at the recommended intervals as well as any calibration carried out during repairs or option upgrades.

⁶ Excluding defects caused by incorrect operation or handling and force majeure. Wear-and-tear parts are not included.



ООО «4ТЕСТ»

Телефон: +7 (499) 685-4444

info@4test.ru

www.4test.ru